

Fohen

# Modena 100° Digital Tap

## Models

CK100 (A,U,X,S) Boiling water system



Fohen verified original instructions: EN version.

# Table of contents

SECTION 1 Using these instructions .....	3
Before you start .....	3
Explanation of symbols .....	3
Explanation of acronyms .....	3
SECTION 2 IMPORTANT SAFETY INSTRUCTIONS.....	4
SECTION 3 WARNINGS & REGULATORY INFORMATION.....	6
SECTION 4 Technical data.....	8
4.1 Explanation of product codes .....	8
4.2 Technical data table.....	8
SECTION 5 Components supplied .....	9
SECTION 6 Installing the system .....	10
6.1 Positioning and air flow .....	10
6.2 Pipes and tubes .....	11
6.3 In cupboard arrangement .....	11
6.4 Push fit best practice .....	12
6.5 Tap installation .....	13
6.6 Tap fitting & connection .....	14
6.7 Connecting the pressure relief valve and filter .....	15
6.8 Connect the water supply.....	16
6.9 Mains water supply arrangement .....	17
6.10 Appliance manifold connections .....	18
6.11 Earth continuity test.....	19
6.12 Connect the electricity supply .....	20
SECTION 7 Commissioning.....	21
7.1 Commissioning, flush and functionality.....	21
SECTION 8 Operation.....	22
8.1 To dispense water from the tap.....	22
SECTION 9 Maintenance .....	23
9.1 Replace and flush the filter .....	23
9.2 Cleaning .....	24
9.3 Draining the tank .....	24
9.4 Checking the pressure relief valve .....	24
SECTION 10 Troubleshooting .....	25
10.1 Troubleshooting the system .....	25

## Table of contents

10.2 In case for accidental freezing.....	25
Environmental information.....	26
Warranty.....	27

## SECTION 1 Using these instructions

### Before you start



Read and use the instructions supplied with individual kit components for a safe installation.

This manual is also available at our website [www.fohen.co.uk](http://www.fohen.co.uk)

### Explanation of symbols



Read the instructions



WARNING



Danger of electric shock



Hot surface

### Explanation of acronyms

DMM - digital multi meter.

## SECTION 2 IMPORTANT SAFETY INSTRUCTIONS



### Compliance

In the UK the system must be installed in accordance with water supply byelaws, current IEEE regulations and local authority byelaws.

### Safety

This appliance is not intended for use by children under 8 years or persons (including children under 8 years) with reduced physical, sensory or mental capabilities, or lack of experience and knowledge, unless they have been given supervision or instruction concerning the use of the appliance by a person responsible for their safety. Children should be supervised to ensure that they do not play with the appliance.

Cleaning and user maintenance shall not be made by children without supervision.

### Qualifications

To avoid hazards, all installation procedures must be carried out by a suitably qualified tradesperson. The power cable and power outlet must be in a safe visible position for connection.

### Venting

Sometimes steam and / or boiling water droplets may discharge through the outlet on the tap.

### Lifting

Take care when lifting. The appliance may exceed safe lifting limits. If you feel this is beyond your personal capabilities, please seek assistance with the lift. Do not lift the appliance by the front cover or any of its connections.

### Airflow

The appliance operates within the ambient temperature range 5°C - 30°C. Proper air circulation must be provided.

### Frost protection

This appliance is not designed for outdoor use. Ensure that the appliance is not installed in an area where the ambient air temperature cannot fall below 5°C and freeze.

## SECTION 2 IMPORTANT SAFETY INSTRUCTIONS

If there is a possibility that the ambient air temperature will fall below 5°C the system must be drained of water, see section 9, Maintenance.

### Servicing

Access to the interior of the appliance to perform service operations is restricted. A screwdriver is required to remove the access covers.

### Application

The appliance is intended to be installed in a domestic environment, where it can be used by members of the public who train themselves in it's use, by reading the instructions supplied with the appliance.

### Special national conditions

This appliance does not comply with special national conditions for Denmark, Sweden, Finland and Norway.

### Mains plug

This appliance is supplied for the UK market and is supplied with a UK mains plug compliant with BS1363.

### Pressure relief valve and tundish

The pressure relief valve must be operated regularly to remove limescale deposits and to verify that it is not blocked.

It is recommended to check this once every 3 months, see by turning the manual pressure relief knob to carry out a drain test, see section 9, Maintenance.

The pressure relief valve tundish must be installed so that it is visible to the users, and is positioned away from any electrical devices.

All discharge pipes; drain valves etc. are to be positioned away from any electrical components.

The discharge pipe connected to the pressure relief valve must be installed in a continuously downward direction in a frost free environment.

## SECTION 3 WARNINGS & REGULATORY INFORMATION



- FOR CONTINUED SAFETY OF THIS APPLIANCE IT MUST BE INSTALLED, OPERATED AND MAINTAINED IN ACCORDANCE WITH THE MANUFACTURER'S INSTRUCTIONS.
-  The under counter boiler must be earthed, earthing is provided via the supplied power cord. The resistance of the earth connection to each exposed metal part must be less than 1Ω. Use the power cable supplied. It is the responsibility of the installer to ensure the power point is earthed.
- All installation and service work must be completed by trained and suitably qualified tradespeople. Faulty operation due to unqualified persons working on this product, may void warranty coverage.
- As the installer, it is your responsibility to supply and install all valves as required by local regulations and relevant standards.
- The appliance is rated for 230V 50Hz AC operation.
- Do not remove the cover of the under counter boiler without first isolating it from the power supply.
- Connect only to a potable (wholesome, cat1) mains water supply.
- Never locate the system near, or clean with water jets.
- Do not expose the system to the elements of nature.
- A pressure limiting valve must be fitted for mains water pressures above the max. limits stated.
- Use of tools can be hazardous, assess the risks before you start.
- A clearance envelope around the under counter appliance must be provided to allow adequate ventilation and service access for its safe and effective use.
- Valve and fitting threads must be sealed appropriately with PTFE tape where compression seals are not provided.
- Do not over tighten plumbing and hose connections.

## SECTION 3 WARNINGS & REGULATORY INFORMATION

- The power cord and power outlet must be in a safe and accessible position after installation. When positioning the under counter appliance, ensure power supply cord is not trapped or damaged. If damaged it must be replaced by a Fohen service provider or a qualified electrician.
- Fohen cannot be held responsible for any appliance malfunction if the water pressure exceeds that stated. If in doubt, consult your water supply company.
- Always flush new filter before use.
- Do not over tighten plumbing and hose connections.
- Braided hoses supplied cannot be lengthened.
- Do not locate multiple portable socket-outlets or portable power supplies at the rear of the appliance.
- Fohen cannot be held responsible for limescale related problems even when a limescale reducer has been installed.
- For safe operation, the appliance is designed to be installed, commissioned and used within 48 hours. Should the appliance not be required for an extended period of time (72 hours or more), do not fill and commission it until ready for first use.
- For water taste and quality reasons, following any non-use period of more than 72 hours, dispense water from the tap using the boiling water button, for 3-5 minutes, before use.
- The new detachable hose sets supplied with the appliance must be used. Do not re-use old hose sets.
- Place the appliance in an environment suitable for its size and use, making sure that it is placed in a horizontal position, make sure that the appliance does not have an inclination greater than 2°.
- The under counter boiler complies with protection class IPX4.

## SECTION 4 Technical data

### 4.1 Explanation of product codes

Range		Tap finish	
CK100	Modena 100 ° Digital Tap	A	Polished Chrome
		U	Unfinished Brass
		X	Matt Black
		S	Brushed Steel

### 4.2 Technical data table

Specification	Unit	Modena 100 ° Digital Tap
Capacity	L	3
Dimensions (W x D x H) (under counter boiler)	mm	200 x 200 x 310
Supply supply	V AC	220-240 (50Hz)
Power rating	kW	2
Fuse rating	A	13
Mains water supply pressure	(bar) MPa	(1 - 6) 0.1-0.6
Fill type		Automatic
Fill time	min.	6
Heat up time 12 °C - 100 °C	min.	12
Functional temperature	°C	5 - 60
ECO temperature	°C	60
Weight (empty), under counter boiler	kg	4.7
Weight (full), under counter boiler	kg	7.7
Boiling water flow rate @ 100 °C	L/min.	2.0
Hot / cold mixed mains flow @ 2.5 bar	L/min.	7.6
Pressure relief valve set opening pressure	bar (MPa)	1.0 (10.0)



## SECTION 5 Components supplied

### 5.1 Supplied parts checklist



An appropriate pressure limiting valve must be fitted in the mains water supply line to the appliance for mains water pressures above 0.6 MPa, in accordance with local plumbing regulations.

- Before starting installation check that you have the following parts.

Qty	Description
<b>Under-counter boiler kit</b>	
1	Under counter Boiler
1	Tee connector
1	Water inlet hose
1	Pressure relief valve
1	Pressure relief valve fixing bracket
4	Pressure relief valve fixing bracket screws
<b>Filter kit</b>	
2	Inlet & outlet connectors
2	John Guest LLDPE Tubing 1/4"
1	Filter head & bracket
1	Dual action filter
<b>Tap kit</b>	
1	Tap, inc. integral hoses and cable
1	Tap stabiliser
1	Tap mounting collar
1	Rubber washer
1	Steel washer

## SECTION 6 Installing the system

### 6.1 Positioning and air flow



Use of tools can be hazardous, assess the risks before you start.



Use instructions supplied with individual kit parts.



- A clearance envelope 50mm both sides and 200mm above the under counter appliance must be provided to allow service access and circulation of air around the under counter boiler for its safe and effective use. (Small components such as the pressure relief valve can be placed above the appliance as these have little effect on air flow).
- Cupboard temperatures should not exceed 30°C.
- Use 4mm door buffers to allow warm air to be drawn into the bottom of the cupboard, and hot air expelled from the top of the cupboard.

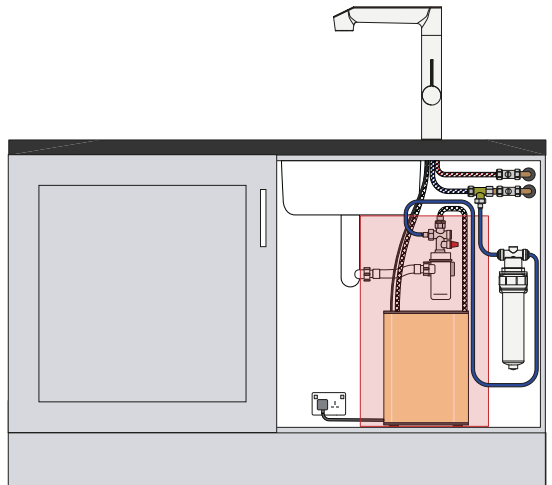

Clearance envelope

## SECTION 6 Installing the system

### 6.2 Pipes and tubes



Install pipes & tubes correctly. No kinks, sags, pinches or loops. Ensure there is a constant fall from the tap down to the appliance.

### 6.3 In cupboard arrangement

- Install the tap as close to the appliance as possible, use the illustration below as a guide, and follow the steps through this section of the manual.

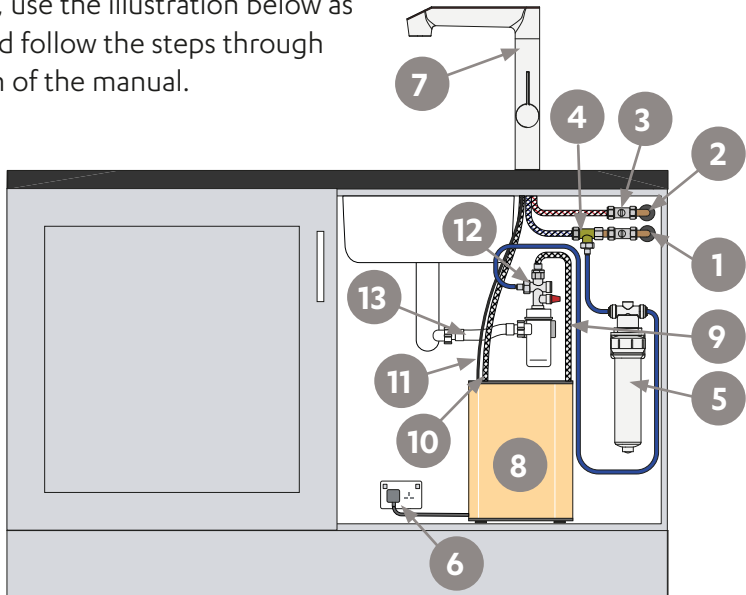

1 Cold Mains water supply.

2 Hot Mains water supply.

3 Mains water Isolation valves.

4 T piece.

5 Filter & filter head.

6 Mains electricity supply.

7 Tap.

8 Under counter appliance.

9 Appliance feed braided hose.

10 Boiling water outlet hose from tap.

11 Tap control cable.

12 Pressure relief valve.

13 Pressure relief valve waste pipe.

## SECTION 6 Installing the system

### 6.4 Push fit best practice

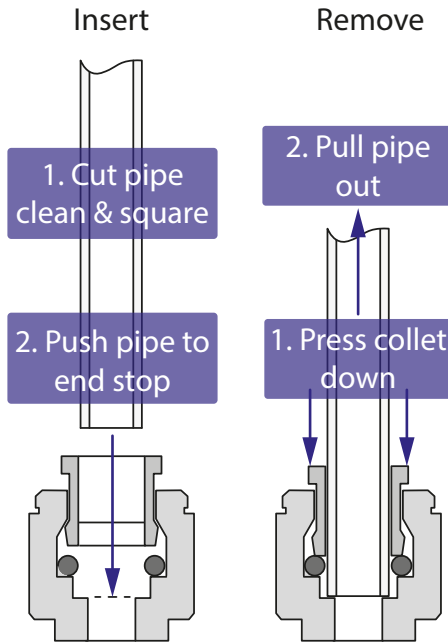

## SECTION 6 Installing the system

### 6.5 Tap installation

#### Tools needed for tap installation

In addition to normal tools, the following (or equivalent equipment) will be required, (not supplied).

- 35mm diameter sheet metal hole punch for sinks.
- 35mm diameter hole saw for worktops.



**Be aware of the risks of hazards which could cause harm when using tools.**

**Assess the risks before starting the installation.**

#### Tap positioning

Position the tap such that it dispenses into the sink bowl with clearance for a cup or tea pot.



**Ensure that taps are positioned to minimise the risks of scalding by dispensing boiling water while using the tap.**

Position the under counter appliance and tap as close together as possible. See below.

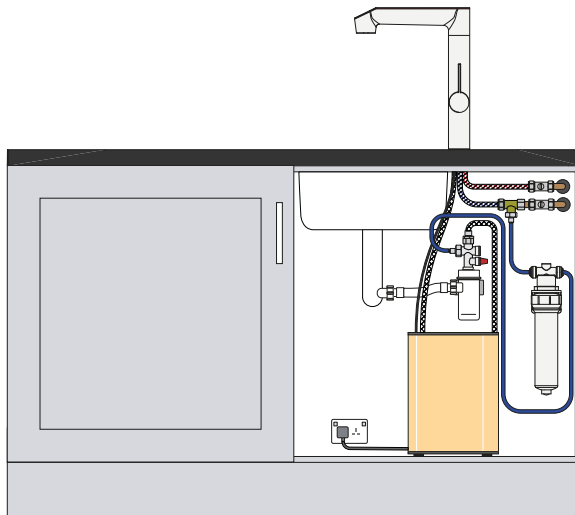

## SECTION 6 Installing the system

### 6.6 Tap fitting & connection

- Familiarise yourself with the tap connections and assembly.
- Cut a 35mm diameter hole in the worktop.
- Insert the tap through the hole.
- Secure from underneath with the tap stabiliser and tap collar.

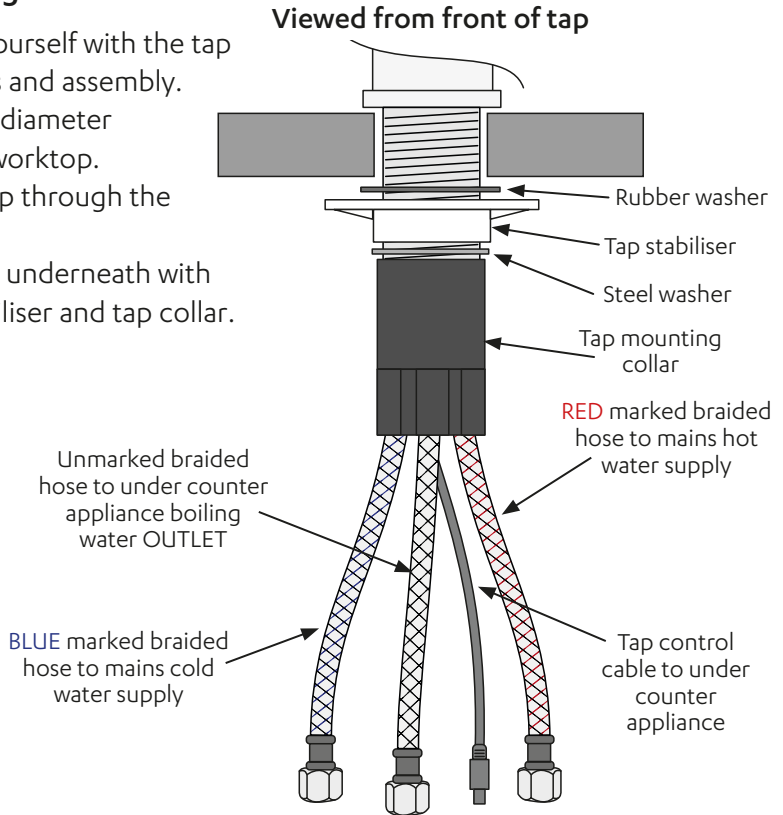

### Tap installation complete

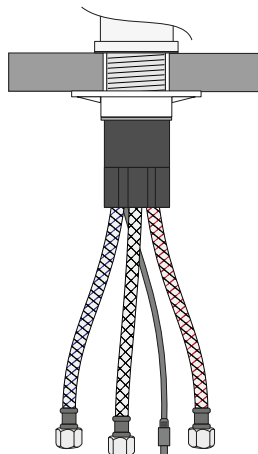

## SECTION 6 Installing the system

### 6.7 Connecting the pressure relief valve and filter

- Connect the pressure relief valve and filter components together, see below. Refer to section 6.3 In cupboard arrangement for complete install layout.
- Refer to section 6.9 Mains water supply arrangement for schematic layout.

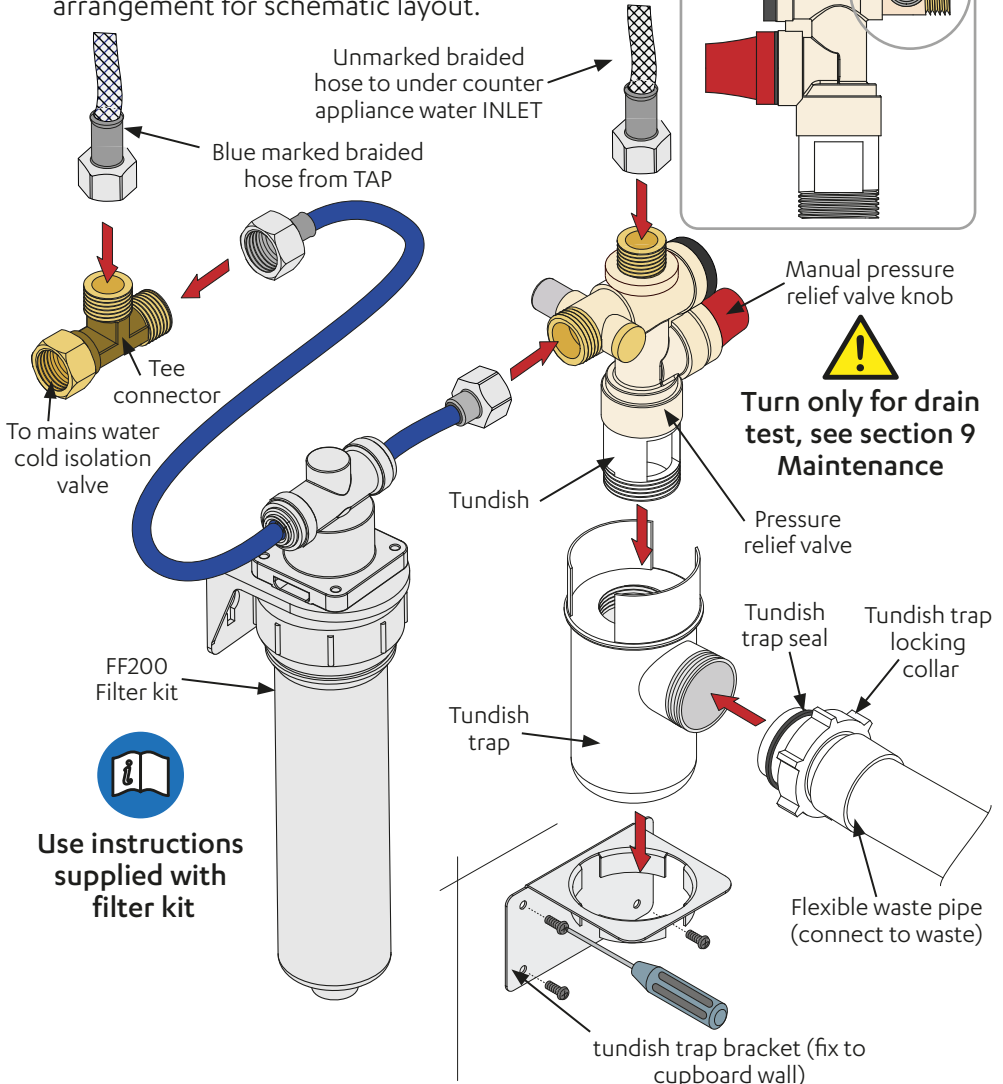

## SECTION 6 Installing the system

### 6.8 Connect the water supply



Valves and fittings must be sealed with PTFE tape if compression seals are not included.

Water supply pressure range 0.1 - 0.6 MPa,  
(recommended 0.2 - 0.5MPa).



If the mains water pressure is below 0.1 MPa a fault could arise.  
If the mains water pressure exceeds 0.6 MPa an appropriate water pressure reducing valve must be fitted. Failure to do so could result in the appliance overflowing.

Fohen cannot be held responsible for any appliance malfunction if the water pressure is not within the range stated. If in doubt, consult your water supply company.



Use instructions supplied with the individual system components.

### Mains water connection

- Connect to a wholesome (cat 1) cold drinking water supply using 15mm copper pipe-work.
- Isolation valves must be fitted.
- Refer to 6.9 Mains water supply arrangement for system schematic and connections.
- Connect the tundish trap to waste using the flexible waste pipe supplied.
- When installing 'push fit' fittings and pipe-work observe push fit best practice, see page 12.
- To install the filter head, use the instructions supplied with it.
- To install the filter, use the instructions supplied with it and refer to page 23.
- The filter must be flushed after installation, see page 21.



## SECTION 6 Installing the system

### 6.9 Mains water supply arrangement



Use instructions supplied with filter kit

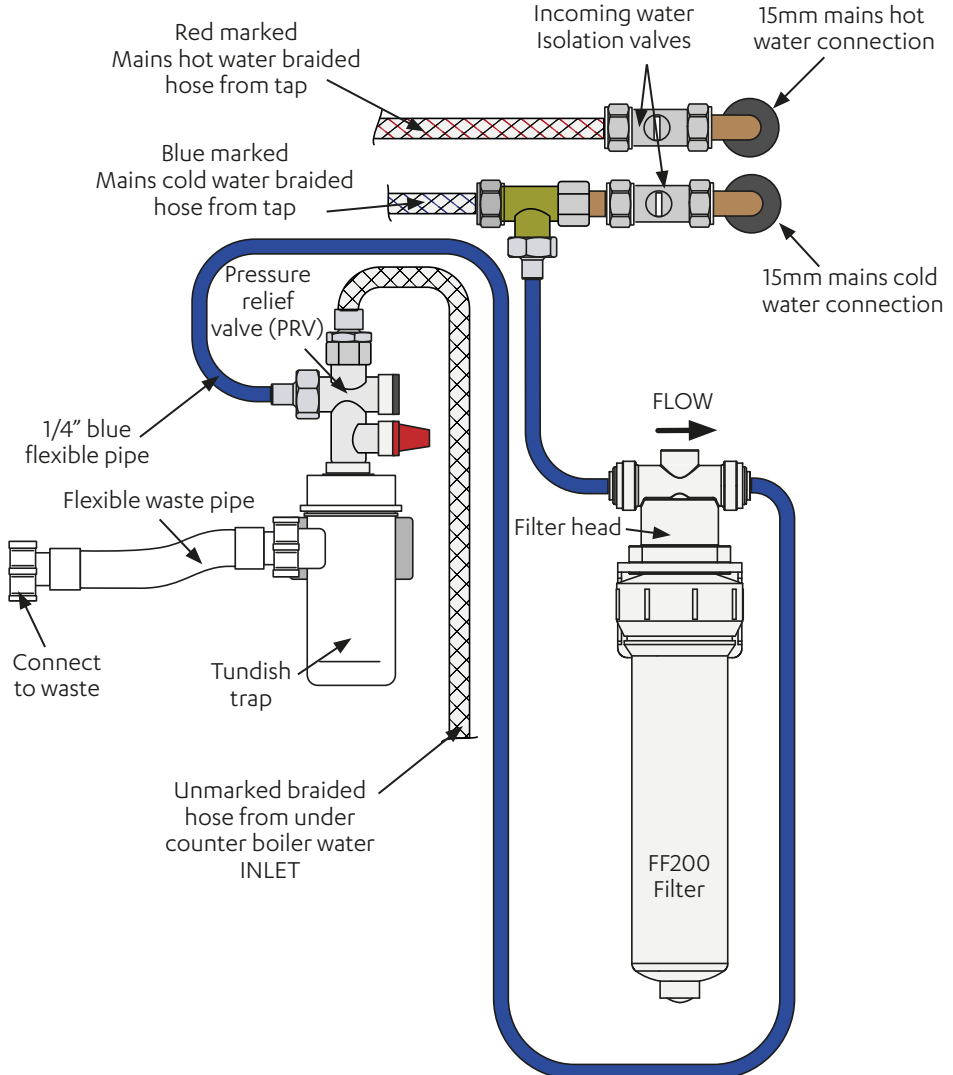

## SECTION 6 Installing the system

### 6.10 Appliance manifold connections

- Connect the unmarked braided hose (boiling water feed) from the tap (see page 14) to the connector at the back of the under counter appliance.
- Connect the control cable from the tap to the under counter appliance (see page 14).
- Connect the unmarked appliance cold water INLET (cold water feed) braided hose from the back of the under counter appliance to the pressure relief valve, see page 15.

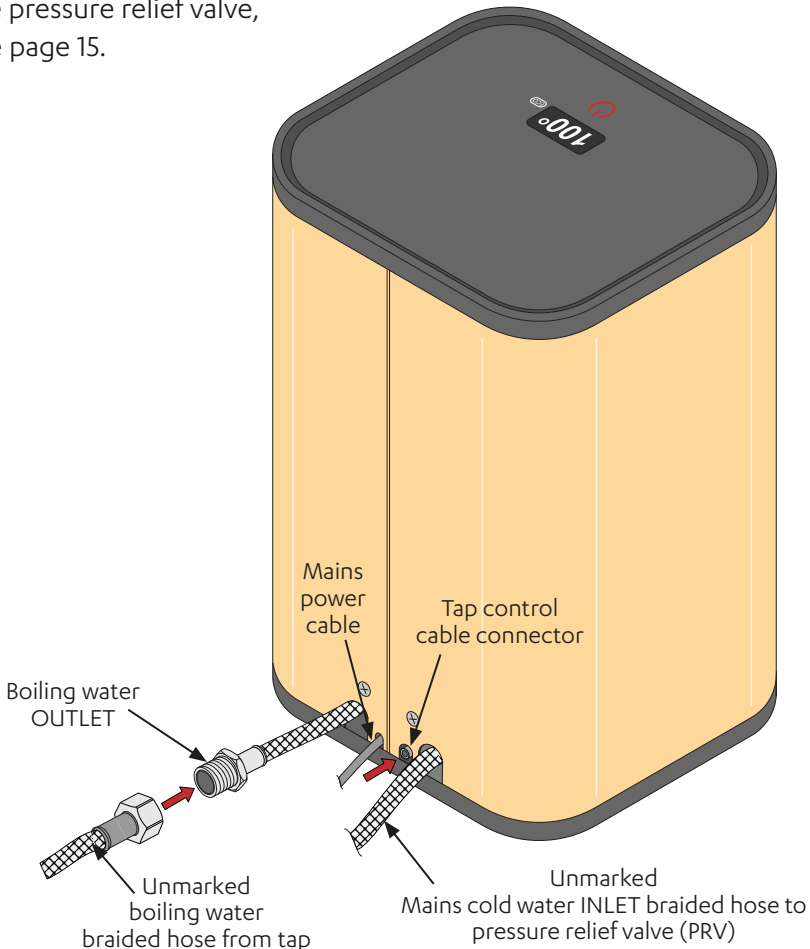

- Using the installation diagrams as a guide, see page 11 & -17 , connect the under counter boiler to the tap.

## SECTION 6 Installing the system

### 6.11 Earth continuity test



**All accessible metal parts must be earthed.**

- Before installation, the earth continuity of the under counter appliance must be checked. Use an insulation tester, appliance tester, DMM or continuity tester with an accuracy of Class 5 or better ( $\pm 5\%$  at full-scale deflection).

#### To test the earth continuity

- Isolate the appliance from the electricity supply.
- Set the meter to the lowest ohms ( $\Omega$ ) scale and set to a reading of  $0\Omega$  with the meter probes connected together.
- Connect one of the meter probes to the earth wire of the mains cable or earth pin of the mains plug.
- Connect the second meter probe to a bare patch of metal or a screw (the edge is best) on the appliance and read the display.
- Repeat with the second test lead touching the metal body of the tap.
- All readings should be less than  $1\Omega$ .
- If any of the reading are above this value, check the earth connection inside the appliance.

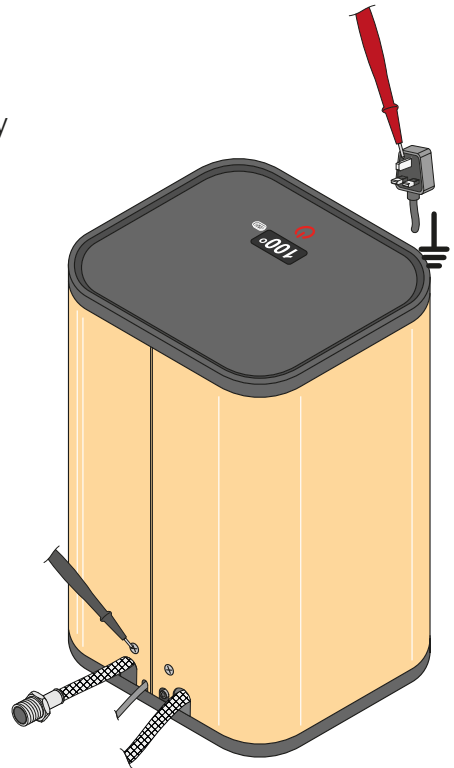

Insulation resistance meter or DMM

## SECTION 6 Installing the system

### 6.12 Connect the electricity supply



Before you start read :  
Section 2 Important Safety Instructions.  
Section 3 Warnings & Regulatory information.

Do not switch on the mains electricity supply until commissioning the system when installation is complete, all electrical /plumbing connections have been made and the earth continuity has been tested.

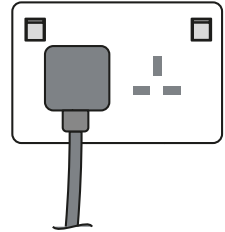

- Connect the under counter appliance mains plug to a 230V 50Hz 13A socket.



## 7.1 Commissioning, flush and functionality



## Under counter appliance

- Turn on the mains water supply.
- Switch on the mains electricity supply to the under counter appliance.
- Touch the tap safety lock  button for approx. 2 seconds until it flashes.
- Touch the boiling water dispense button on the tap  to start system flush, water will be flushed for 2 minutes, then automatically stop.
- Touch the heating button  on the under counter appliance display panel for approx. 2 seconds to initiate the heating function.
- When the temperature display reaches 100°C the tap is ready to dispense.

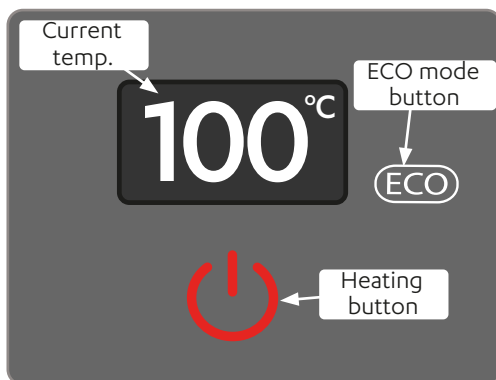

Under counter appliance buttons and indicators

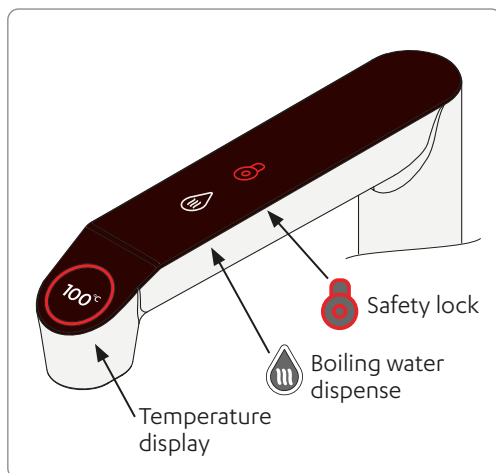

Tap buttons and indicators

ECO mode 

- With the appliance switched on and the heating button illuminated, press the ECO button for approx. 2 seconds.
- The ECO button will illuminate, and the appliance will enter ECO mode to save energy.
- To return to normal function, press the ECO button for approx. 2 seconds.

## SECTION 8 Operation



### 8.1 To dispense water from the tap

- Ensure that the under counter boiler is switched on and ready to use. See section 7.

#### Boiling water



**Caution, boiling water is dispensed from the spout.**

- To dispense boiling water, press the **safety lock button**  for approx. 2 seconds.
- The lights will flash.
- Press the **boiling water button**  to dispense.

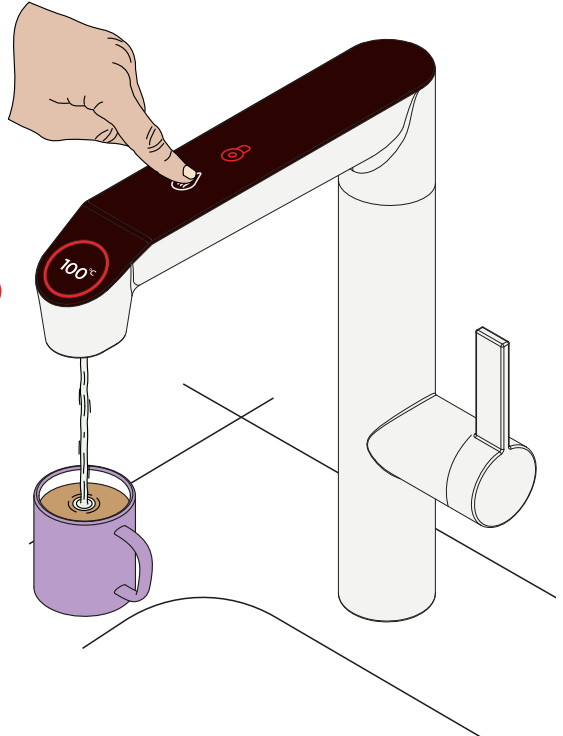

#### Mixed water

- To dispense mixed warm water for washing up, pull the right hand control away from the tap body.
- Twist front - back, to change the mixed water temperature.
- Warmer - backward, cooler - forward.
- Twist left to right to change the mixed water flow rate, (see adjacent).

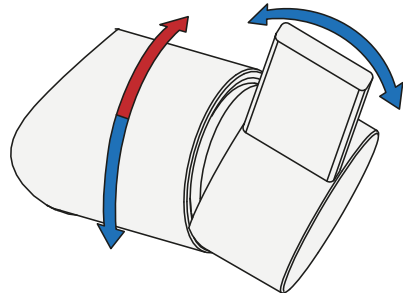

## SECTION 9 Maintenance

### 9.1 Replace and flush the filter



Not changing the filter cartridge when required may affect the water quality.

Filter change intervals: no more than 12 months.



Use instructions supplied with the filter cartridge.

### Replace the FF200 filter

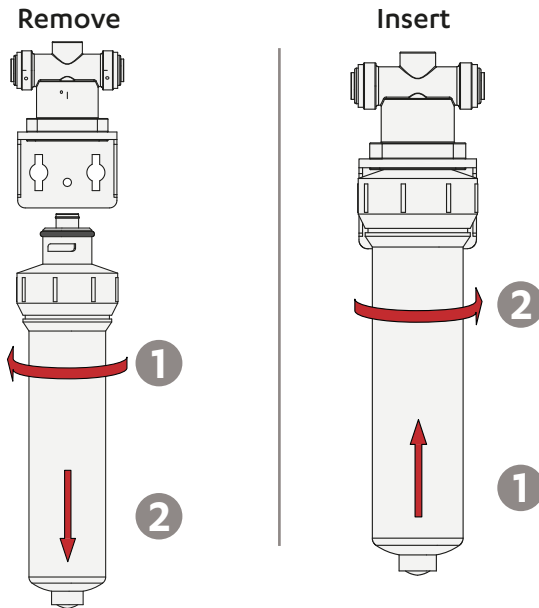

- Turn OFF the power supply to the under counter appliance.
- Turn OFF the cold mains water supply isolation valve.
- Remove the old filter (see above).
- Be aware that some water may drip from the filter head.
- Remove the sanitary cap from the new filter, do not touch the connector.
- Moisten the new filter connector with clean tap water.
- Insert the new filter (see above).
- Turn ON the cold mains water supply isolation valve.
- Flush the filter, see Section 7. Touch the heating button  on the under counter appliance display panel for 2 seconds to initiate heating function.
- Wait for the temperature to show 100°C before dispensing water.

### 9.2 Cleaning



Cleaning of the tap and dispensing outlets must only be undertaken with alcohol or sanitising wipes. Chemicals should NOT be sprayed onto the tap or under counter appliance at any time.

Never use strong, corrosive or abrasive cleaning materials on the tap or under counter appliances.

**This could cause permanent malfunction and void warranty.**

- To clean tap, under-counter appliance and ancillaries, wipe surfaces with a sanitising wipe and leave to air dry.

### 9.3 Draining the tank

- Leave the tank standing for more than 10 hours to make sure that the internal boiling water temperature has dropped to ambient.
- Disconnect the power supply, switch off the mains water supply and remove the connected hoses from the under counter boiler.  
Place the under counter boiler in a sink and unscrew the hexagonal drain plug at the centre of the boiler base, water will drain out of the drain hole.
- When empty, re-fit the drain plug and reinstall the under counter boiler, to return the system to functionality.

### 9.4 Checking the pressure relief valve



**WARNING ! Hot surfaces, scalding water.**

- Check every 3 months.
- Touch the heating button  on the under counter appliance display panel to turn OFF the heating function.
- Dispense boiling water for 3-5 minutes (using the tap), before operation of the pressure relief valve, to avoid scalding.
- Turn the red manual pressure relief knob clockwise to carry out a drain test.
- Check that water flows through the tundish.
- Call Fohen on 0808 196 2480 for advice, if water does not flow.



## SECTION 10 Troubleshooting

### 10.1 Troubleshooting the system



**Before you start read :**

**Section 2 Important Safety Instructions.**

**Section 3 Warnings & Regulatory information.**

Error code	Possible causes	Action
E01 Lack of water or dry heating.	NTC sensor temperature exceeds 120°C or thermostat has a current signal.	Check the water supply, if okay Isolate appliance from the mains water and electricity supplies & call Fohen on 0808 196 2480 .
E02 Temperature sensor abnormality.	Turn on the heating for 2 minutes, the temperature continues without change.	Isolate appliance from the mains water and electricity supplies. Call Fohen on 0808 196 2480.
E03 Tap no communication.	The Tap is not communicating with the under counter appliance.	Check the tap control cable connection, if okay, isolate appliance from the mains water and electricity supplies call Fohen on 0808 196 2480 .
E04 Heating abnormality.	When the temperature sensor is normal, there is no change in temperature after switching on the heating.	Isolate appliance from the mains water and electricity supplies Call Fohen on 0808 196 2480.
E05 Water leakage.	Liquid in bottom of appliance, leakage detection line conductive.	Isolate appliance from the mains water and electricity supplies. Call Fohen on 0808 196 2480.

### 10.2 In case for accidental freezing



**Before you start read :**

**Section 2 Important safety instructions.**

**Section 3 Warnings & Regulatory information.**

- Ensure that ambient environmental conditions around the appliance are above the minimum operating temperature of the appliance.
- Turn off the electricity and water supplies for 12 hours to allow the appliance to defrost, then turn back on.

### Waste electrical and electronic equipment

- The symbol above means that according to United Kingdom and European Union member countries laws and regulations, your product and/ or its battery shall be disposed of separately from household waste.
- When this product reaches its end of life, take it to a collection point designated by local authorities. The separate collection and recycling of your product and/ or its battery at the time of disposal will help conserve natural resources and ensure that it is recycled in a manner that protects human health and the environment.

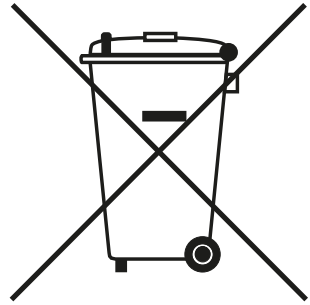

## Warranty

### Warranty

- For more information please refer to the online [Fohen Warranty Policy](#).

# fohen

Fohen UK  
Trafalgar House  
Rash's Green  
Dereham  
Norfolk  
NR19 1JG

0808 196 2480  
hello@fohen.co.uk  
[www.fohen.co.uk](http://www.fohen.co.uk)

